

WORKING LOAD LIMIT (WLL)

Imperial Nominal	Metric Nominal	Axial WLL tonnes	Trunion Type Mounting WLL tonnes	Perpendicular Type Mounting WLL tonnes	0° - 30° WLL tonnes	31° - 60° WLL tonnes	61° - 90° WLL tonnes
							
3/8"	M10	0.25	0.06	0.12	0.31	0.20	0.12
1/2"	M12	0.40	0.10	0.20	0.50	0.32	0.20
N/A	M14	0.40	0.10	0.20	0.50	0.32	0.20
5/8"	M16	0.80	0.20	0.40	1.00	0.64	0.40
N/A	M18	0.80	0.20	0.40	1.00	0.64	0.40
3/4"	M20	1.60	0.40	0.80	2.00	1.28	0.80
7/8"	M22	2.00	0.50	1.00	2.50	1.60	1.00
1"	M24	2.50	0.62	1.25	3.10	2.00	1.25
1.1/8"	M30	4.00	1.00	2.00	5.00	3.20	2.00
1.1/4"	M33	5.00	1.25	2.50	6.30	4.00	2.50
N/A	M36	6.30	1.57	3.10	7.90	5.00	3.10
1.1/2"	M39	7.00	1.75	3.50	8.80	5.60	3.50
1.3/4"	M42	8.00	2.00	4.00	10.00	6.40	4.00
2"	M48	10.00	2.50	5.00	12.60	8.00	5.00
N/A	M56	15.00	3.70	7.50	18.90	12.00	7.50
2.1/2"	M64	20.00	5.00	10.00	25.00	16.00	10.00
N/A	M72	25.00	6.20	12.50	31.00	20.00	12.50
3"	M76	30.00	7.50	15.00	37.00	24.00	15.00

DIMENSIONS

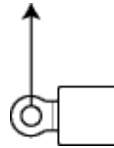
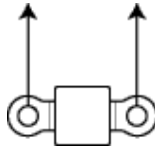
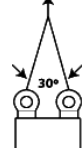
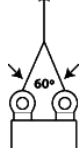
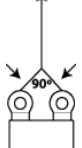
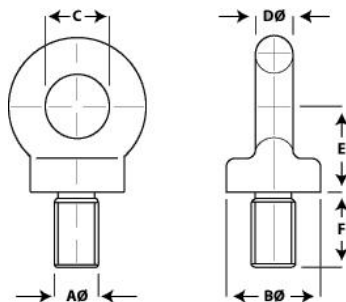

Imperial AØ	Metric AØ	BØ	C	DØ	E	F	Net Weight (kg)
3/8"	M10	21	14	9	19	18	0.06
1/2"	M12	28	18	11	24	22	0.15
1/2"	M14	35	24	15	31	27	0.28
5/8"	M16	35	24	15	31	27	0.28
5/8"	M18	42	29	16	35	40	0.46
3/4"	M20	42	29	16	35	40	0.46
7/8"	M22	50	33	20	41	41	0.85
1"	M24	57	38	22	48	42	0.85
1 1/4"	M27	71	48	28	65	52	2.10
1 1/4"	M30	71	48	28	65	52	2.10
1 1/4"	M33	71	48	28	65	52	2.20
1 1/2"	M36	86	55	33	73	63	3.70
1 1/2"	M39	86	55	33	73	64	3.70
1 3/4"	M42	102	68	40	90	79	6.30
2"	M48	115	76	49	99	89	9.50
2 1/2"	M56	143	97	56	124	116	19.50
2 1/2"	M64	143	97	56	124	116	19.50
3"	M76	163	98	66	140	125	29.00

Townley Drop Forge Pty Ltd

96 John Street, P.O. Box 12, Brunswick East, Victoria, 3057

Tel: +61 3 9387 4155 Fax: +61 3 9387 3685

Email: sales@townleydropforge.com.au Web: www.townleydropforge.com.au